

Page 4 - Sudoku 4x4

1	3	2	4
2	4	1	3
3	1	4	2
4	2	3	1

1	4	3	2
3	2	1	4
4	1	2	3
2	3	4	1

Page 5 - Break the Code

OAK

ELM

PINE

Page 6 - Magic Square

6	11	4
5	7	9
10	3	8

Page 7 - Pile Up

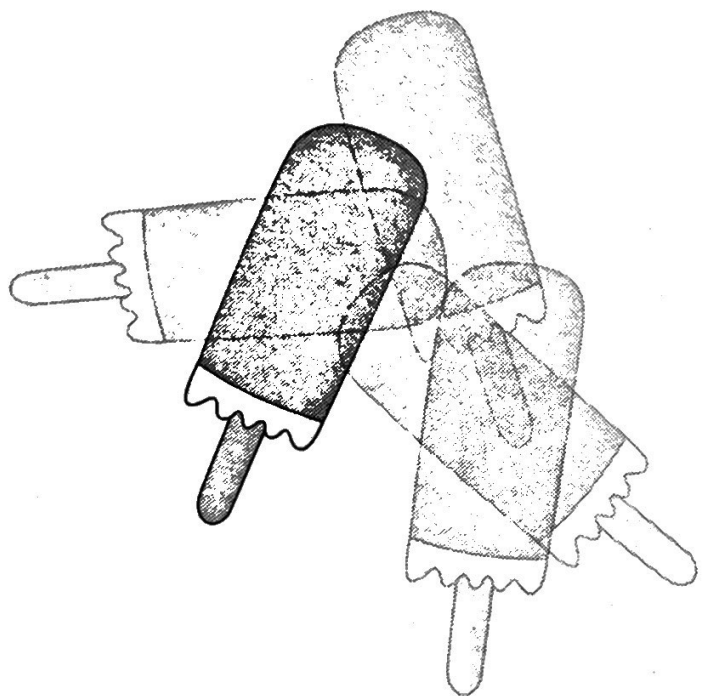

Page 8 - Kriss Kross

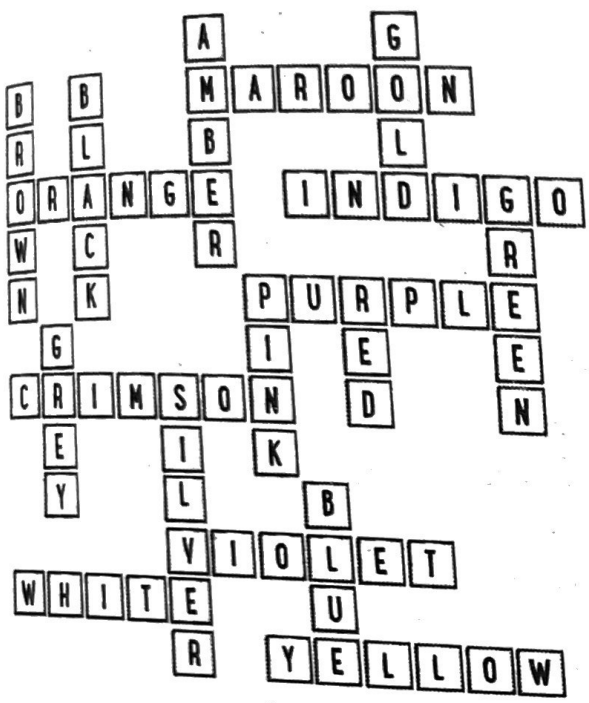

Page 9 - Shape Sum

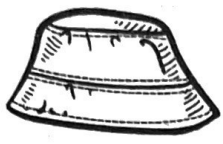

= 3



= 4

Page 10 - Key Match



Page 11 - Sudoku 4x4

2	1	4	3
4	3	1	2
3	4	2	1
1	2	3	4

4	1	2	3
3	2	1	4
1	3	4	2
2	4	3	1

Page 12 - Star Battle

This page in the book is an example of a Star Battle puzzle and how to complete it.

Page 13 - Star Battle

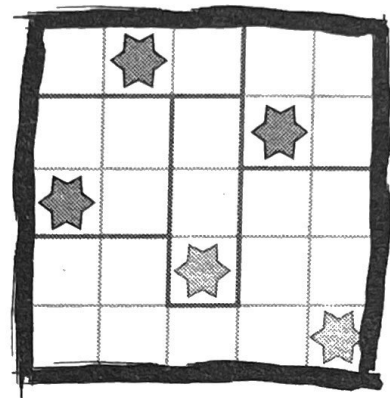
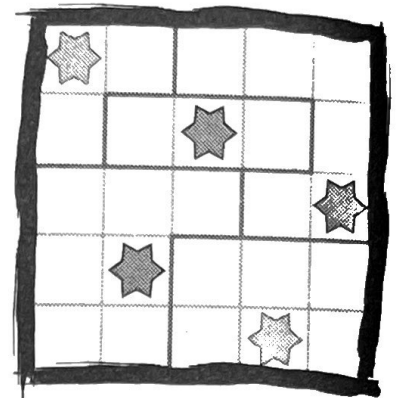

Page 14 - Star Battle

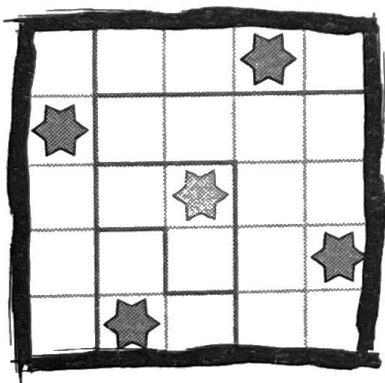
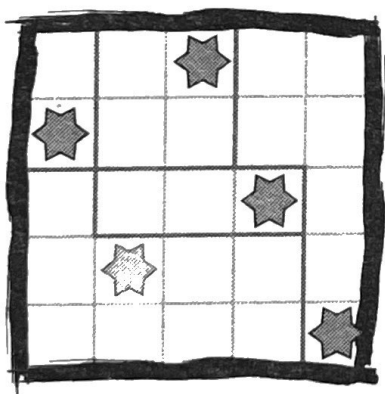

Page 15 - Star Battle

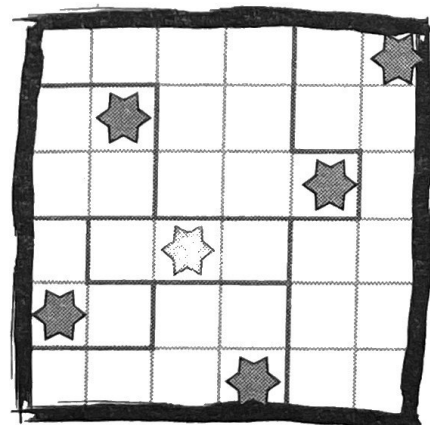
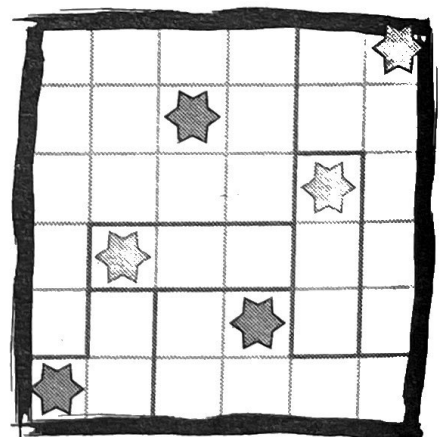

Page 16 - Star Battle

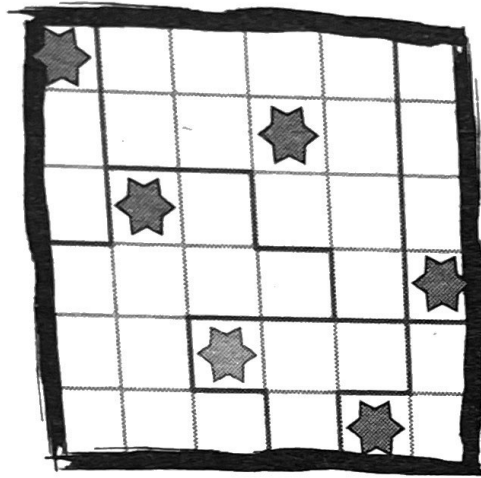
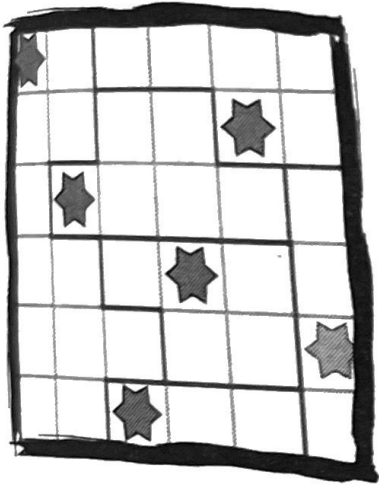
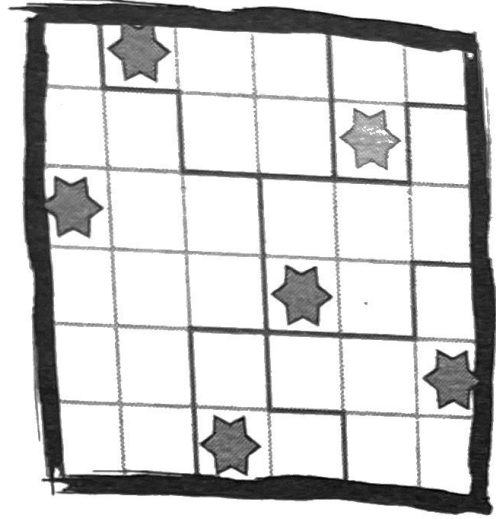
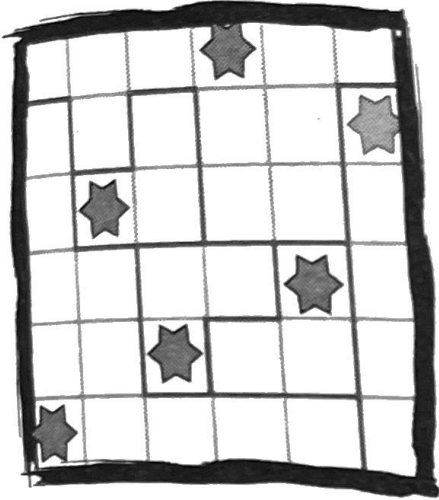

Page 18 - No Four in a Row

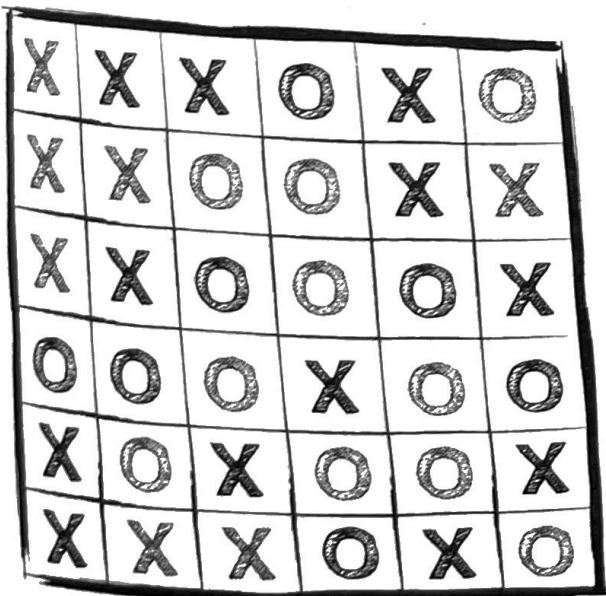

Page 17 - Star Battle

Page 19 - Logic Puzzle

		PUPPY	BICYCLE	FOOTBALL	ICE SKATES	JANUARY	MARCH	JUNE	DECEMBER
Girl	MYRA	X	X	X	✓	✓	X	X	X
Boy	ARTHUR	X	✓	X	X	X	✓	X	X
Boy	OMAR	X	X	✓	X	X	X	X	✓
Girl	LILY	✓	X	X	X	X	X	✓	X
	JANUARY	X	X	X	✓				
	MARCH	X	✓	X	X				
	JUNE	✓	X	X	X				
	DECEMBER	X	X	✓	X				

Girl	MYRA	ICE SKATES	JANUARY
Boy	ARTHUR	BICYCLE	MARCH
Boy	OMAR	FOOTBALL	DECEMBER
Girl	LILY	PUPPY	JUNE

Page 20 - Morse Code



Page 21 - Number Square

5	×	7	-	4	31
×		-		×	
9	÷	3	+	8	11
-		×		+	
2	×	6	÷	1	12
43		24		33	

Page 22 - Break the Code

BAT

WITCH

GHOST

Page 23 - Kriss Kross

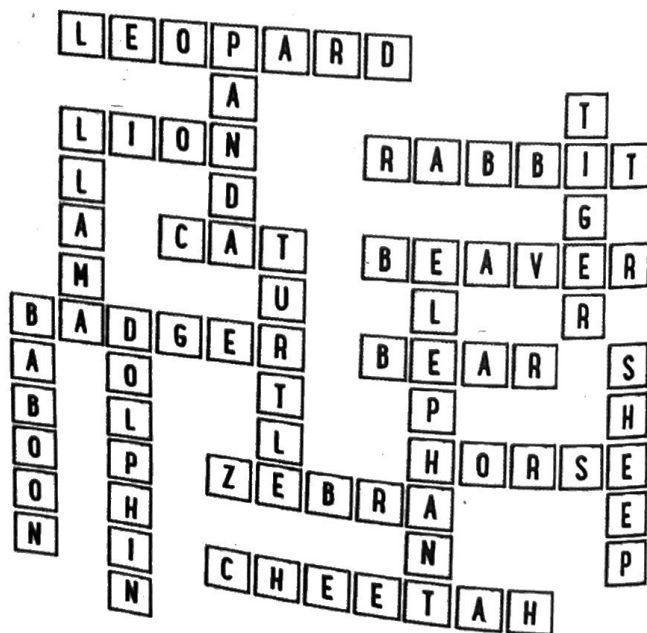

Page 24 - Jigsaw Split

This page in the book is an example of a Jigsaw Split puzzle and how to complete it.

Page 25 - Jigsaw Split

A	W	A	R	E
B	E	G	I	N
P	A	P	E	R
R	O	S	E	S
M	E	L	O	N

Page 26 - Jigsaw Split

A	G	R	E	E
H	O	R	S	E
R	O	C	K	S
L	E	A	R	N
T	O	P	I	C

Page 27 - Jigsaw Split

P	A	L	A	C	E
T	U	R	T	L	E
I	M	A	G	E	S
S	Q	U	A	S	H
R	A	B	B	I	T
F	R	E	E	Z	E

Page 28 - Sudoku 4x4

3	4	2	1
2	1	3	4
1	3	4	2
4	2	1	3

2	3	4	1
4	1	2	3
3	2	1	4
1	4	3	2

Page 29 - Magic Square

14	7	12
9	11	13
10	15	8

Page 30 - Shape Sum



= 5



= 8

Page 31 - Key Match



6

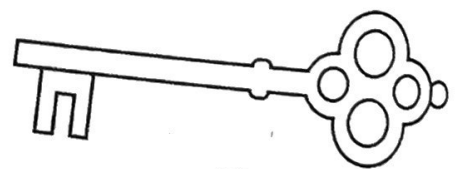

2

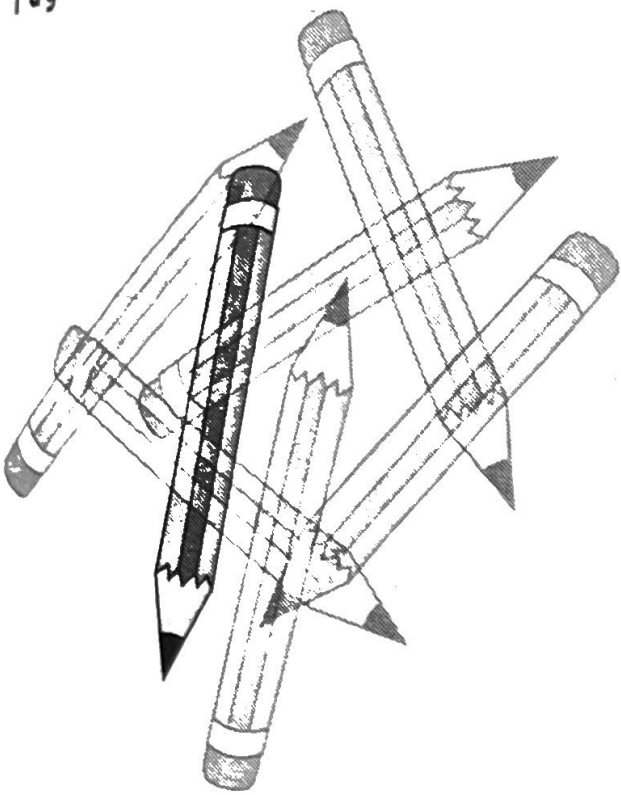

O	X	X	O	X	O
X	X	O	X	X	O
O	O	X	X	O	O
X	O	X	O	O	X
X	O	X	X	O	X
X	X	O	O	X	X

		THE ZOO	THE BEACH	THE CINEMA	SHOPPING	WEDNESDAY	FRIDAY	SATURDAY	SUNDAY
Girl	HENNAH	X	✓	X	X	X	✓	X	X
Boy	ISAAC	X	X	✓	X	✓	X	X	X
Boy	STANLEY	✓	X	X	X	X	X	X	✓
Girl	OLIVIA	X	X	X	✓	X	X	✓	X
	WEDNESDAY	X	X	✓	X				
	FRIDAY	X	✓	X	X				
	SATURDAY	X	X	X	✓				
	SUNDAY	✓	X	X	X				

1	2	4	3
4	3	1	2
2	1	3	4
3	4	2	1

3	4	2	1
1	2	4	3
2	1	3	4
4	3	1	2

Girl	HENNAH	THE BEACH	FRIDAY
Boy	ISAAC	THE CINEMA	WEDNESDAY
Boy	STANLEY	THE ZOO	SUNDAY
Girl	OLIVIA	SHOPPING	SATURDAY

Page 36 - Loop

This page in the book is an example of a Loop puzzle and how to complete it.

Page 37 - Loop

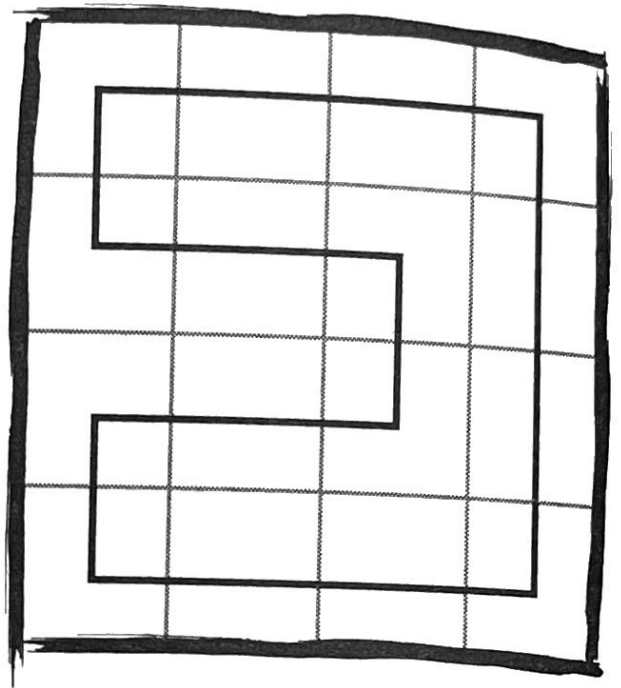

Page 38 - Loop

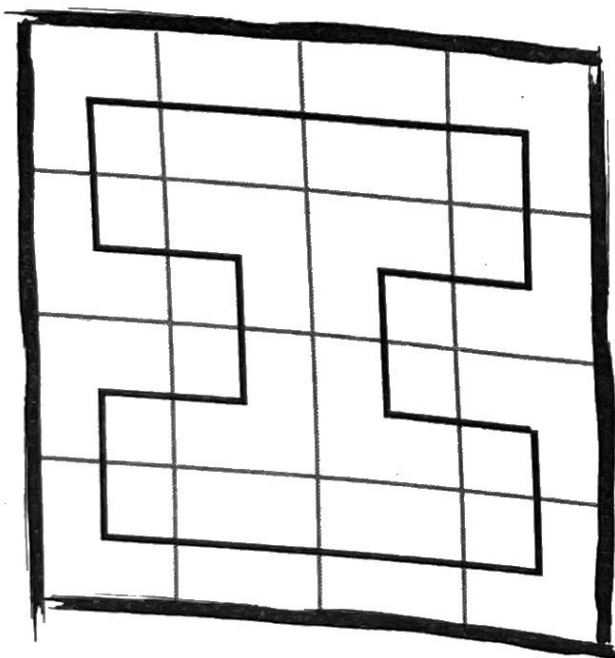

Page 39 - Loop

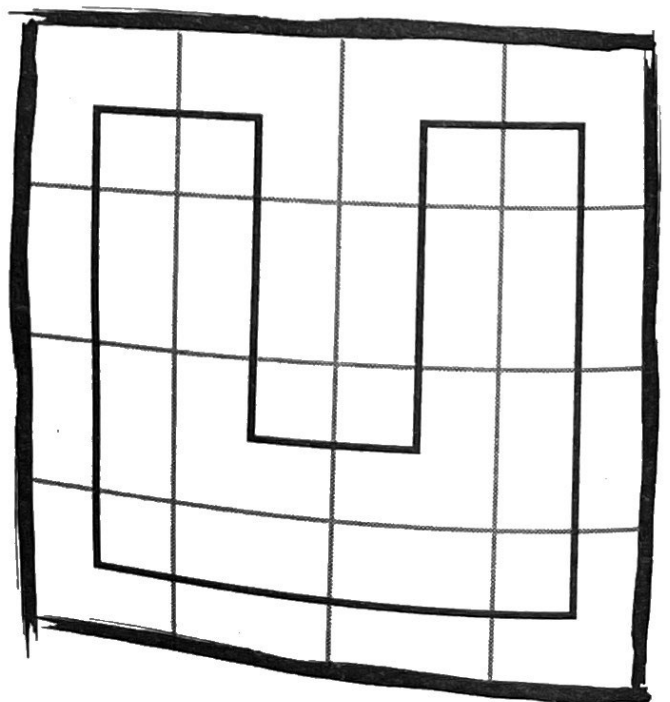

Page 40 - Loop

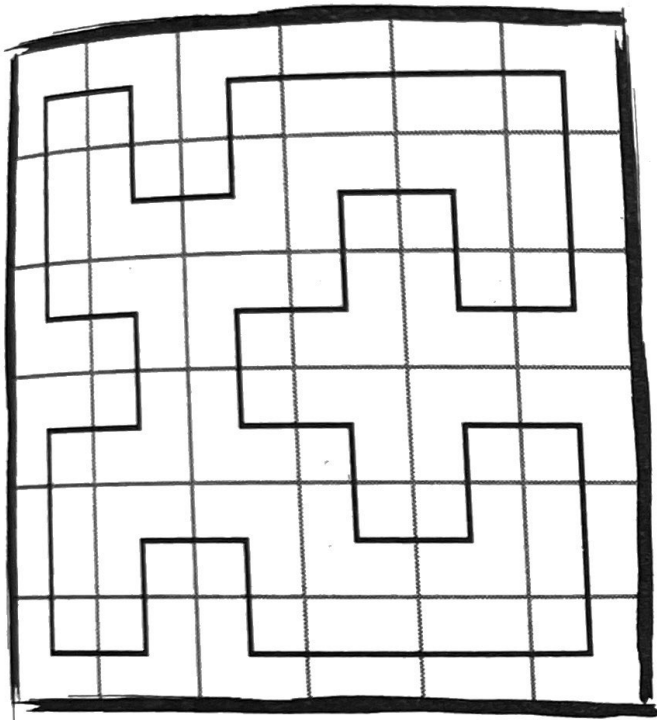

Page 41 - Loop

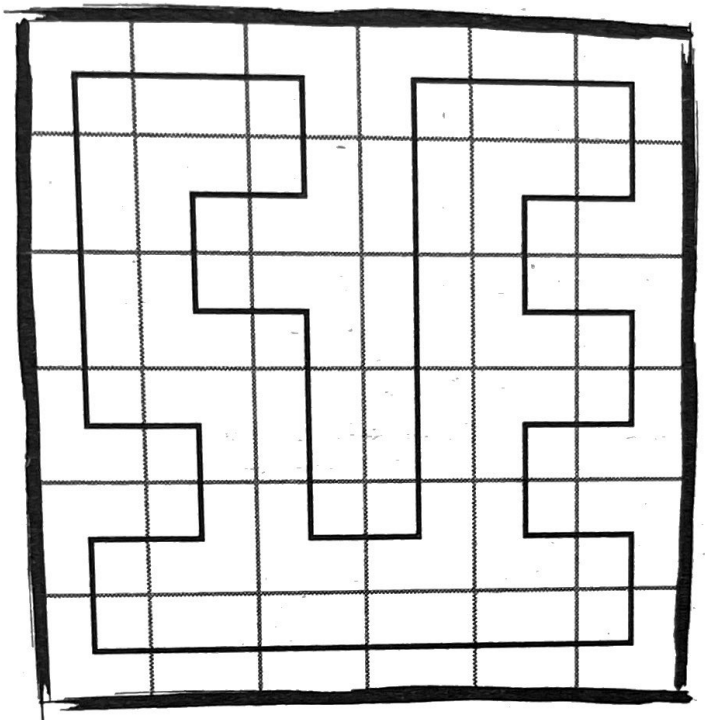

Page 42 - Kriss Kross

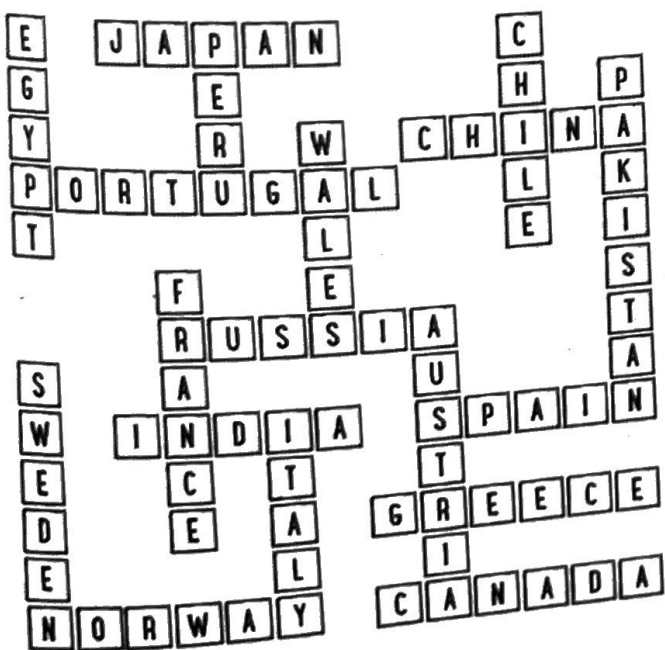

Page 43 - Break the Code

CROWN
PRINCE
QUEEN

Page 44 - Number Square

3	*	4	-	2	10
*		+		+	
9	÷	1	*	8	72
+		+		-	
6	*	5	-	7	23
33		10		3	

Page 45 - Morse Code



Page 46 - Magic Square

3	8	7
10	6	2
5	4	9

Page 47 - Shape Sum



= 5



= 2



= 7

Page 48 - Kakuro

This page in the book is an example of a Kakuro puzzle and how to complete it.

Page 49 - Kakuro

		6	7
	4	3	1
6	3	1	2
7	1	2	4

Page 50 - Kakuro

	15	12	17	
6	2	3	1	7
27	7	4	9	8
54	8	3	2	1
11	9	5	7	6
27	3	1	2	
6				

Page 51 - Kakuro

		4	7	
	3	1	2	5
18	1	3	4	2
10	1	3	1	3
4	7	9	8	
24	2	5	1	
6				

Page 52 - Sudoku 4x4

3	1	4	2
4	2	1	3
2	4	3	1
1	3	2	4

2	4	1	3
3	1	2	4
4	2	3	1
1	3	4	2

Page 53 - Pile Up

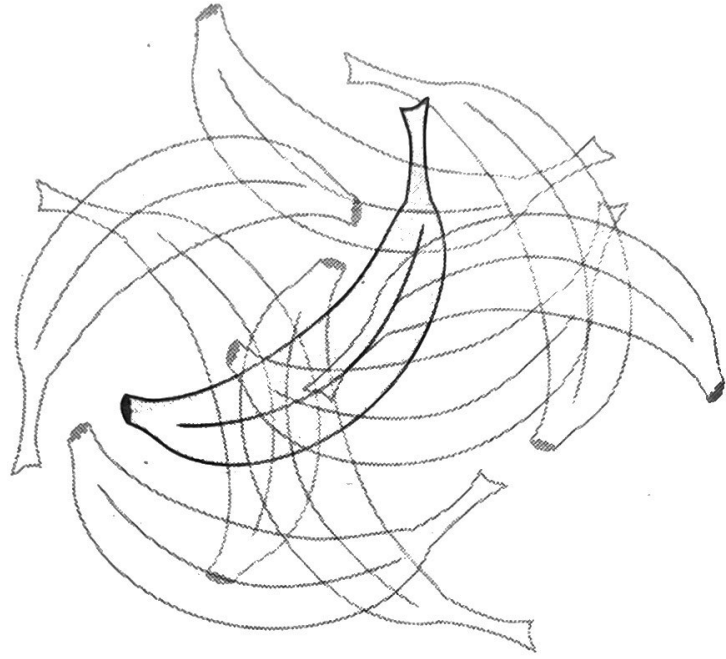

Page 54 - Key Match

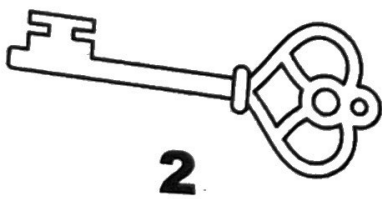

2

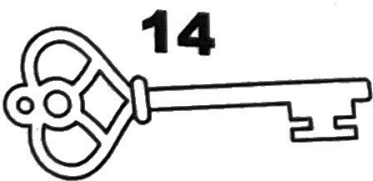

14

Page 55 - Kriss Kross

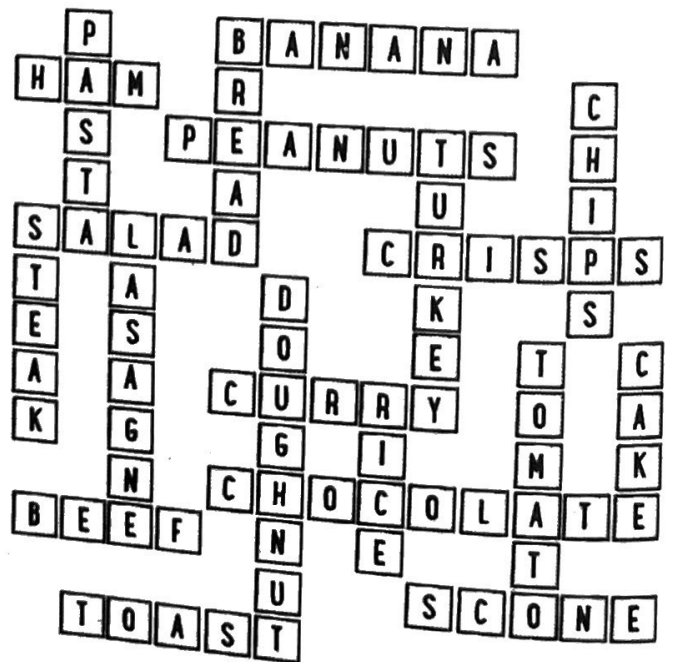

Page 56 - No Four in a Row

O	X	O	O	O	X	X	X
X	O	X	O	X	X	X	O
O	O	X	X	X	O	X	O
O	X	O	O	O	X	O	O
O	X	O	O	O	X	O	X
X	X	X	O	X	X	O	X
O	O	X	X	O	O	X	X
O	X	O	O	O	X	X	O

Page 57 - Logic Puzzle

		HIKING	SAFARI	CARNIVAL	BEACH	CHATEAU	CANADA	KENYA	BRAZIL	INDIA	FRANCE
Girl	SARAH	X	✓	X	X	X	X	✓	X	X	X
Boy	PIERRE	✓	X	X	X	X	✓	X	X	X	X
Boy	IMRAN	X	X	X	X	✓	X	X	X	X	✓
Girl	MAYA	X	X	✓	X	X	X	X	✓	X	X
Boy	JAMES	X	X	X	✓	X	X	X	X	✓	X
	CANADA	✓	X	X	X	X					
	KENYA	X	✓	X	X	X					
	BRAZIL	X	X	✓	X	X					
	INDIA	X	X	X	✓	X					
	FRANCE	X	X	X	X	✓					

Girl	SARAH	SAFARI	KENYA
Boy	PIERRE	HIKING	CANADA
Boy	IMRAN	CHATEAU	FRANCE
Girl	MAYA	CARNIVAL	BRAZIL
Boy	JAMES	BEACH	INDIA

Page 58 - Bridges

This page in the book is an example of a Bridges puzzle and how to complete it.

Page 59 - Bridges

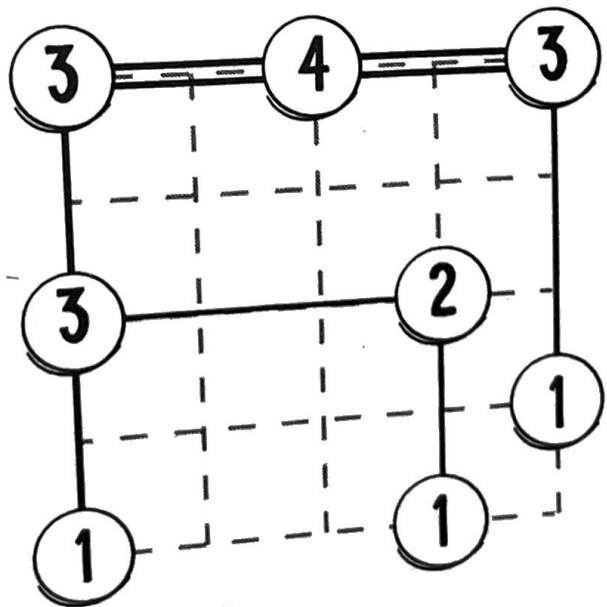

Page 60 - Bridges

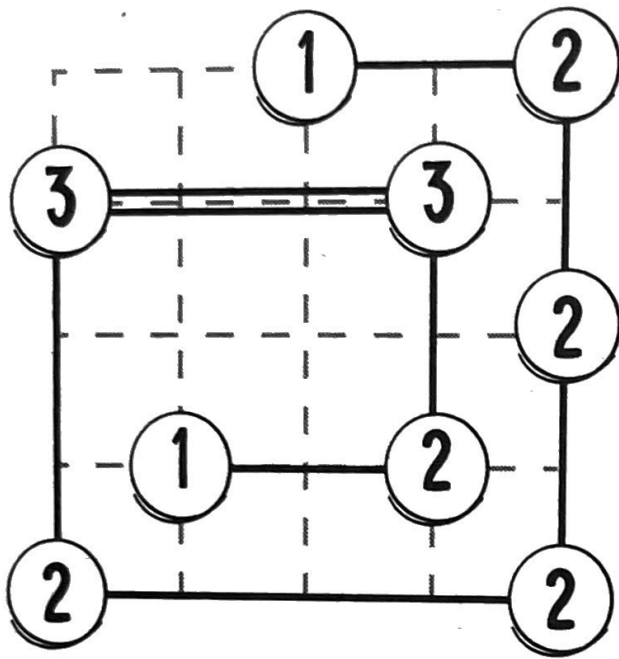

Page 61 - Bridges

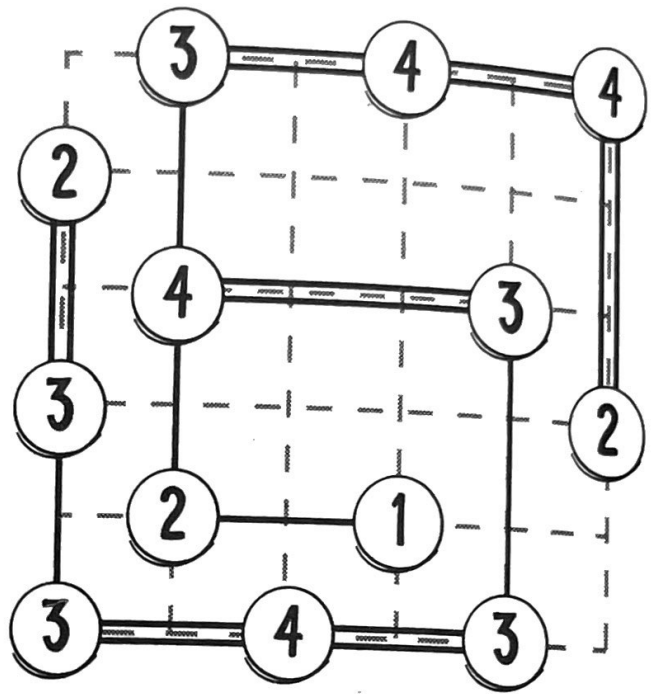

Page 62 - Bridges

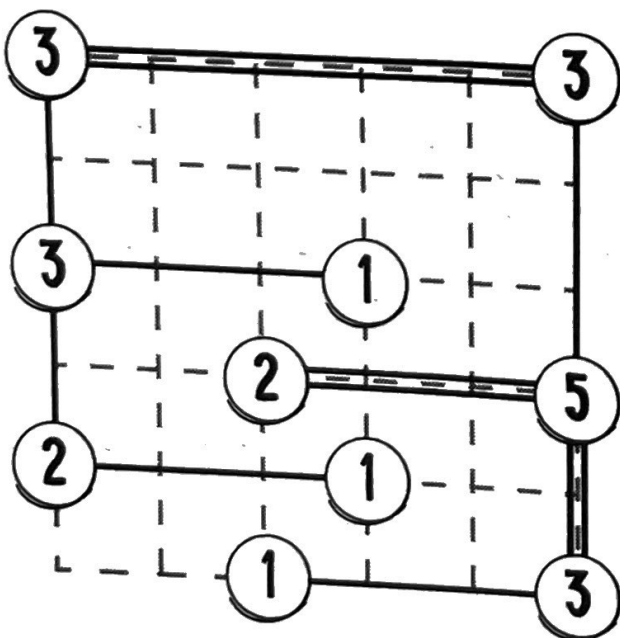

Page 63 - Bridges

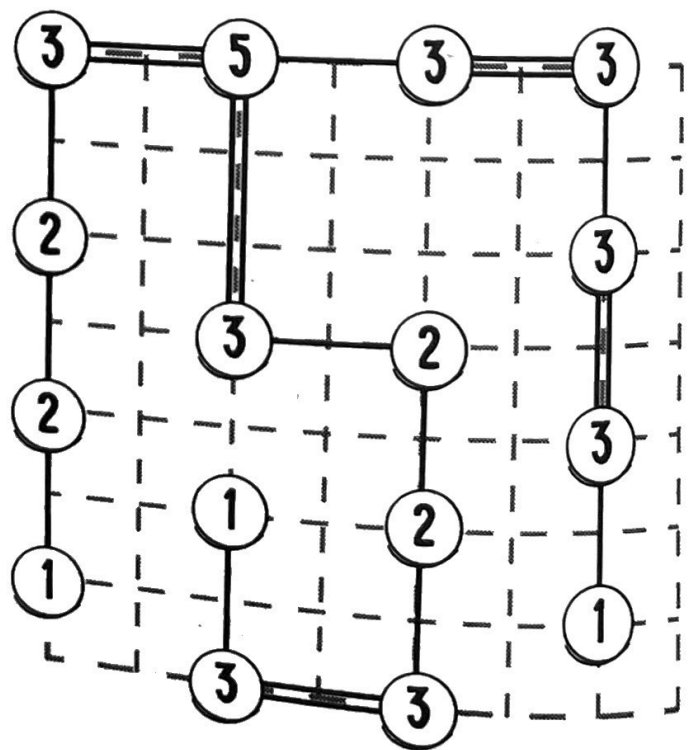

Page 64 - Break the Code

THUNDER
LIGHTNING
SUNSHINE

Page 65 - Sudoku 6x6

6	3	1	4	5	2
2	4	5	1	3	6
4	2	6	3	1	5
5	1	3	2	6	4
3	5	2	6	4	1
1	6	4	5	2	3

Page 66 - Morse Code



Page 67 - Number Square

8	x	7	+	5	61
+		+		+	
1	x	4	-	3	1
+		-		+	
6	x	2	x	9	108
15		9		17	

Page 68 - Shape Sum

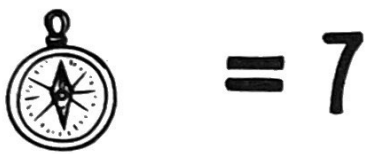
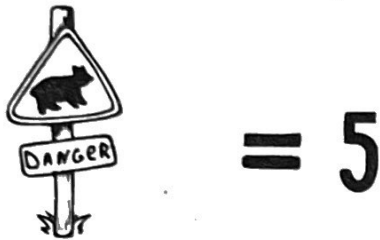
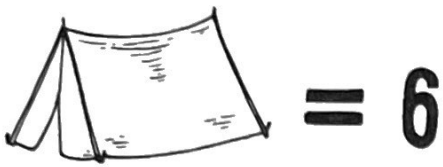

Page 69 - Magic Square

8	7	16	15
13	10	5	18
11	12	19	4
14	17	6	9

Page 70 - King's Journey

This page in the book is an example of a King's Journey puzzle and how to complete it.

Page 71 - King's Journey

5	4	3	2
6	7	8	1
16	13	11	9
15	14	12	10

10	12	16	14
9	11	13	15
7	8	1	3
6	5	4	2

Page 72 - King's Journey

7	6	5	4	3
8	10	11	1	2
9	12	17	23	24
13	16	18	25	22
14	15	19	20	21

Page 73 - King's Journey

14	15	17	24	25
13	16	18	23	22
4	12	19	20	21
3	5	11	10	9
2	1	6	7	8

10	12	13	14	
6	11	18	17	15
7	1	19	21	16
2	6	20	24	22
3	4	5	23	25

9	8	7	2	3
10	11	1	6	4
12	13	20	21	5
14	17	19	22	25
15	16	18	23	24

Page 74 - King's Journey

25	24	22	20	19	17
27	26	23	21	18	16
28	29	2	1	15	14
30	31	4	3	12	13
30	35	32	5	11	10
34	33	6	7	8	9

Page 75 - King's Journey

27	28	29	14	13	12
26	30	36	34	15	11
25	31	35	33	16	10
23	24	32	17	9	4
21	22	18	8	5	3
20	19	7	6	2	1

15	16	18	19	23	24
14	17	20	22	26	25
9	13	21	27	29	30
8	10	12	28	31	32
6	7	11	1	34	33
5	4	3	2	36	35

31	30	29	22	21	20
32	34	35	28	23	19
7	33	36	27	24	18
6	8	26	25	17	14
1	5	9	16	15	13
2	3	4	10	11	12

Page 76 - Pile Up

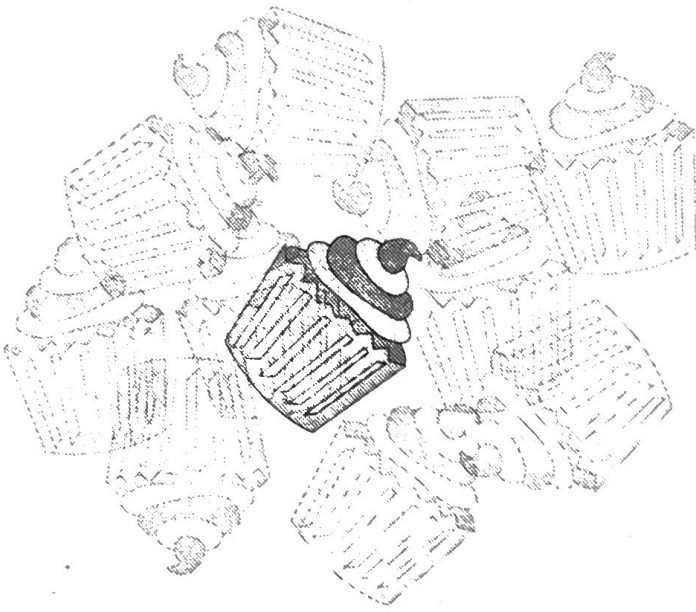

Page 77 - Kriss Kross

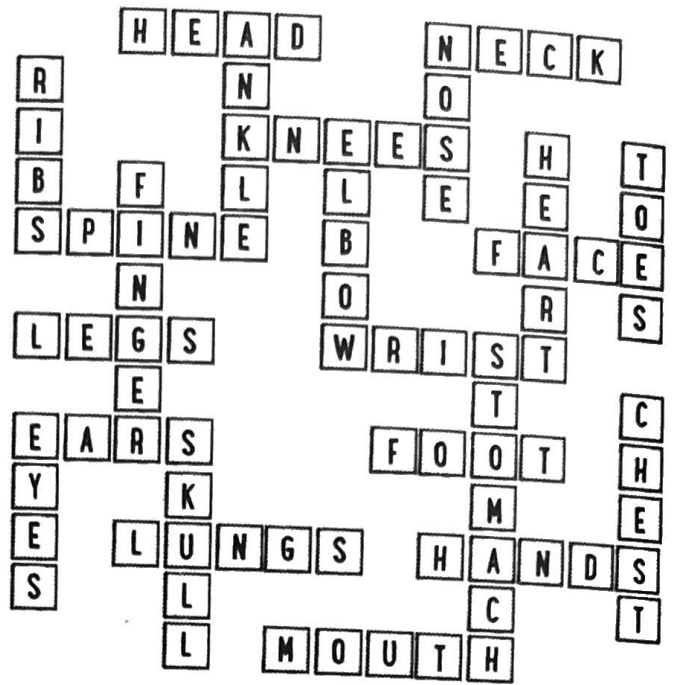

Page 78 - Sudoku 6x6

6	3	1	5	2	4
5	4	2	3	1	6
1	5	4	2	6	3
2	6	3	1	4	5
4	1	5	6	3	2
3	2	6	4	5	1

Page 79 - Morse Code



Page 80 - Logic Puzzle

		ODIN	CHARLIE	PERCY	FLUFFY	MAGIC	CAT	HAMSTER	GOLDFISH	DOG	SNAKE
Girl	AISHA	X	X	X	X	✓	✓	X	X	X	X
Girl	TILLY	X	X	✓	X	X	X	X	✓	X	X
Boy	LUKE	✓	X	X	X	X	X	X	X	X	✓
Girl	CHLOE	X	X	X	✓	X	X	✓	X	X	X
Boy	MOHAMMED	X	✓	X	X	X	X	X	X	✓	X
	CAT	X	X	X	X	✓					
	HAMSTER	X	X	X	✓	X					
	GOLDFISH	X	X	✓	X	X					
	DOG	X	✓	X	X	X					
	SNAKE	✓	X	X	X	X					

Girl	AISHA	CAT	MAGIC
Girl	TILLY	GOLDFISH	PERCY
Boy	LUKE	SNAKE	ODIN
Girl	CHLOE	HAMSTER	FLUFFY
Boy	MOHAMMED	DOG	CHARLIE

Page 81 - Number Square

5	x	6	+	4	34
x		x		+	
7	+	2	-	3	6
-		x		+	
9	+	1	x	8	80
26		12		15	

Page 82 - Square Up

This page in the book is an example of a Square Up puzzle and how to complete it.

Page 83 - Square Up

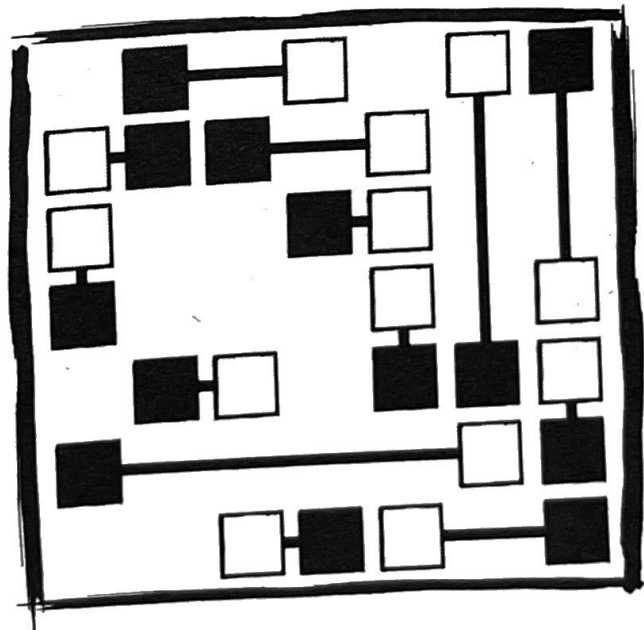

Page 84 - Square Up

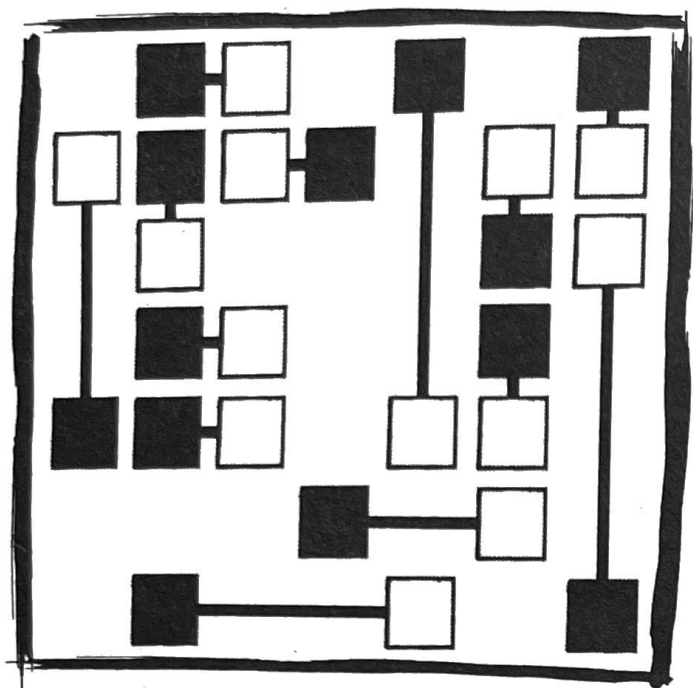

Page 85 - Square Up

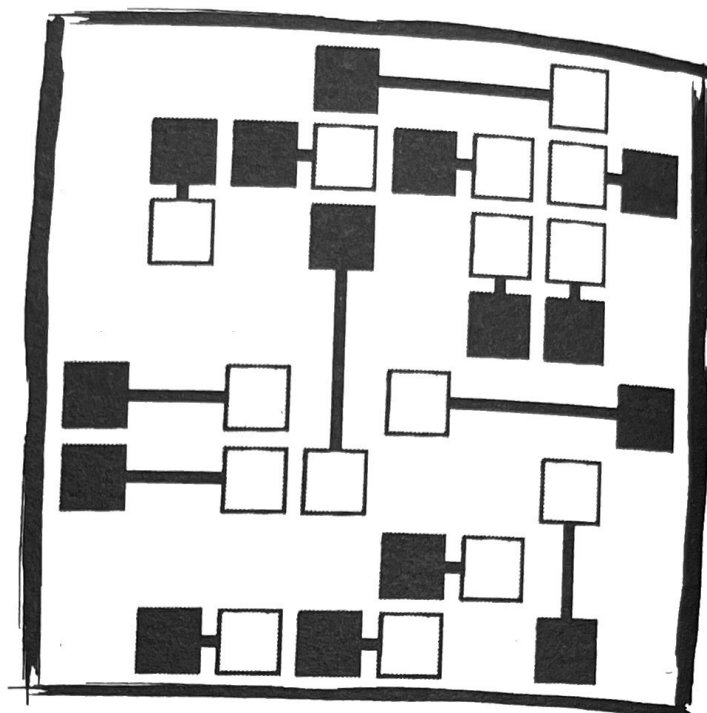

Page 86 - Square Up

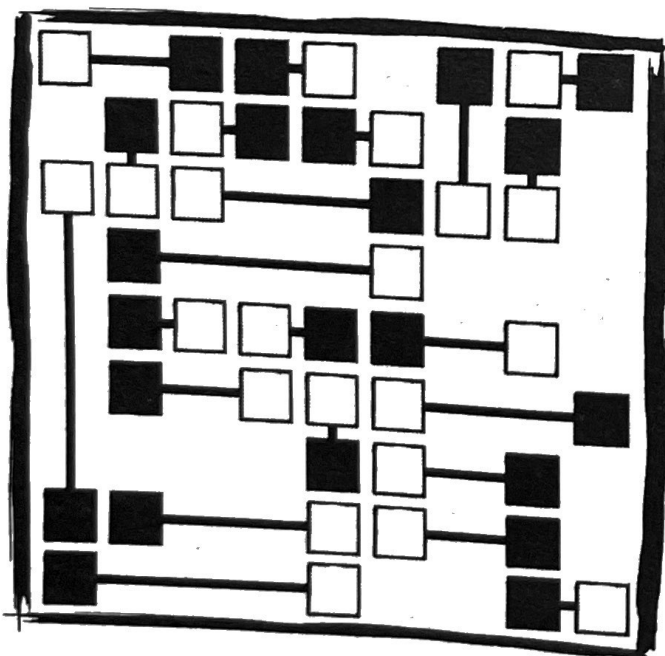

Page 87 - Square Up

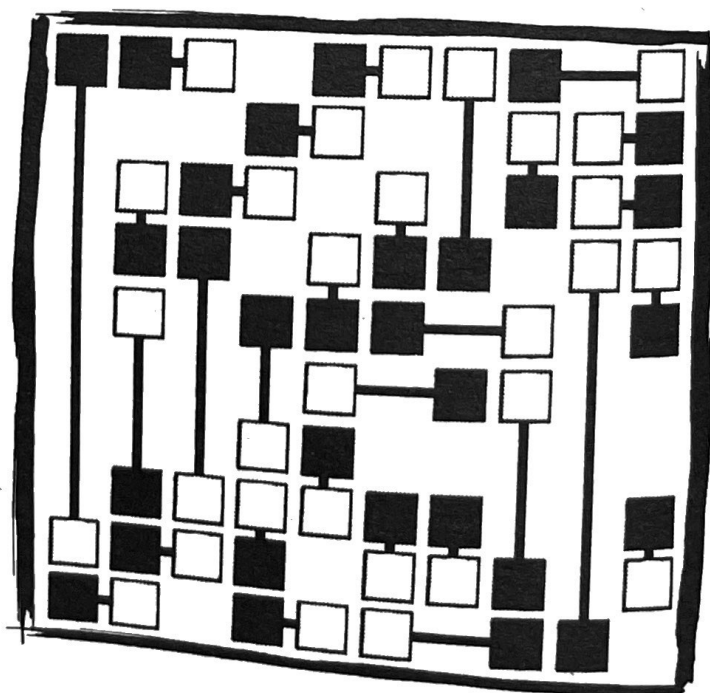

Page 88 - Key Match

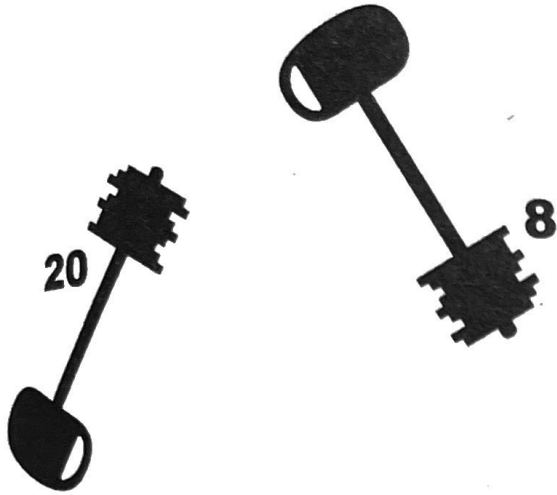

Page 89 - No Four in a Row

X	X	O	X	X	O	O	X
O	O	X	O	O	X	O	X
O	O	X	X	O	X	O	X
X	X	X	O	O	X	X	O
O	X	O	X	X	O	X	O
O	X	O	X	X	O	X	X
O	O	O	X	O	O	O	X
X	X	X	O	O	X	X	X

Page 90 - Break the Code

PEKINGESE
DACHSHUND
CHIHUAHUA

Page 91 - Sudoku 6x6

6	4	2	1	3	5
5	3	1	2	4	6
3	2	6	4	5	1
1	5	4	6	2	3
2	6	5	3	1	4
4	1	3	5	6	2

Page 92 - Kriss Kross

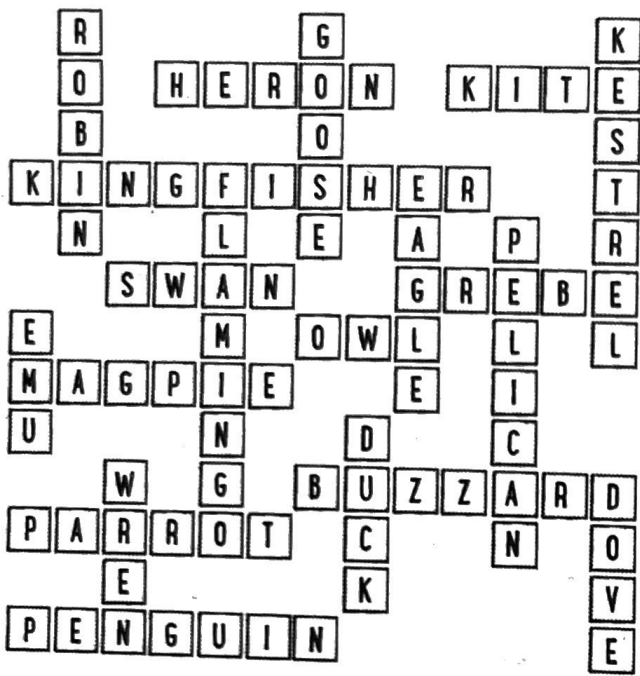

Page 93 - Shape Sum



= 5



= 6



= 8

Page 94 - Fences

This page in the book is an example of a Fences puzzle and how to complete it.

Page 95 - Fences

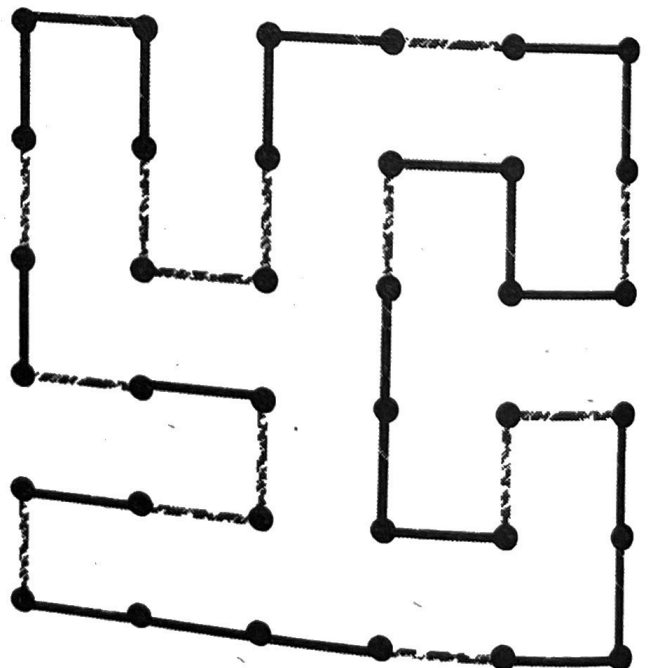

Page 96 - Fences

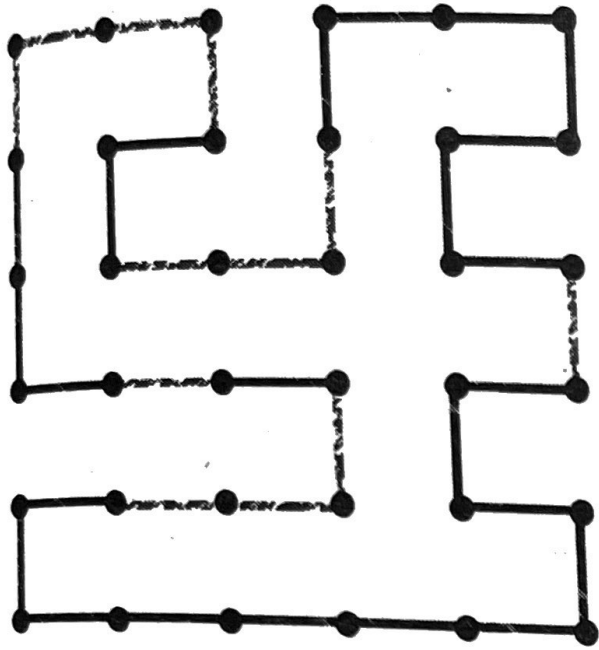

Page 97 - Fences

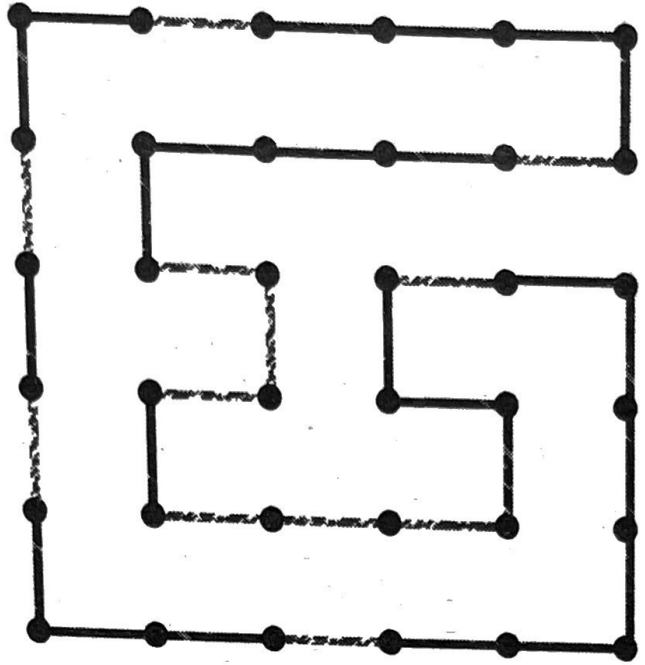

Page 98 - Fences

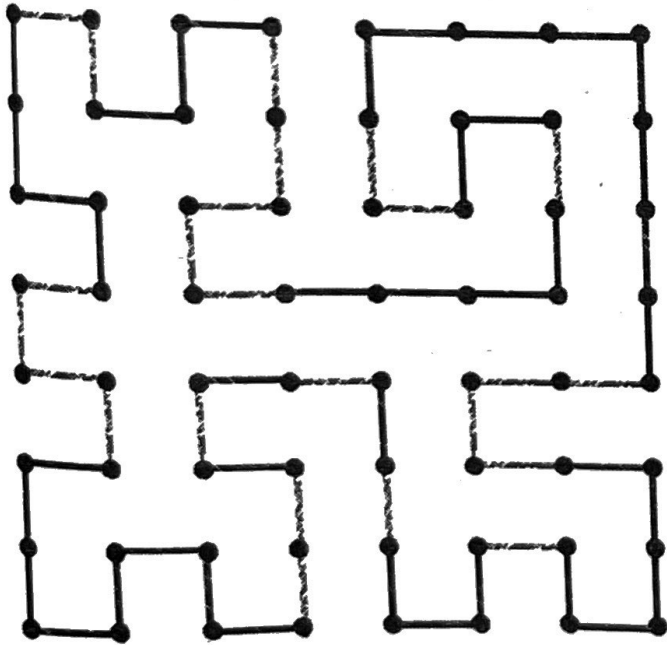

Page 99 - Fences

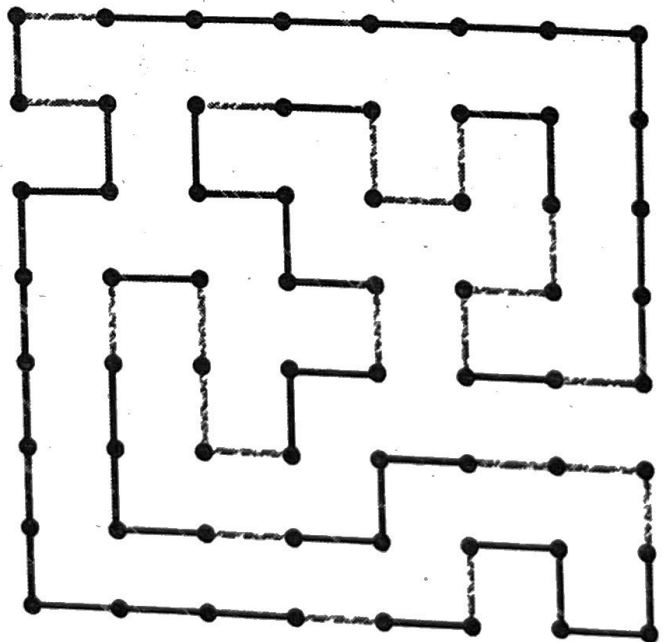

Page 100 - Number Square

4	÷	2	+	5	7
+		×		-	
8	+	7	+	3	18
×		+		÷	
9	+	6	×	1	15
108		20		2	

Page 101 - Pile Up

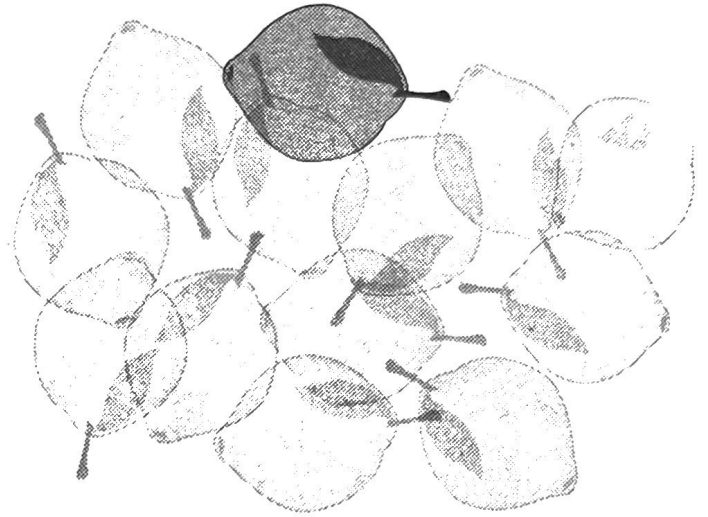

Page 102 - Magic Square

18	13	7	16
15	8	10	21
12	19	17	6
9	14	20	11

Page 103 - Morse Code



Page 104 - Sudoku 6x6

3	1	6	5	4	2
4	2	5	6	1	3
1	6	2	3	5	4
5	4	3	2	6	1
6	3	1	4	2	5
2	5	4	1	3	6

Page 105 - Logic Puzzle

		HOLIDAY	HOME	GRANDPARENTS	SCHOOL	DAY TRIP	SNOW	SUNSHINE	RAIN	WINDY	CLOUDY
Girl	AMARA	X	✓	X	X	X	✓	X	X	X	X
Boy	BRUNO	X	X	✓	X	X	X	X	✓	X	X
Boy	YOUSSEF	X	X	X	✓	X	X	X	X	✓	X
Girl	GIA	✓	X	X	X	X	X	✓	X	X	X
Girl	LUCY	X	X	X	X	✓	X	X	X	X	✓
	SNOW	X	✓	X	X	X					
	SUNSHINE	✓	X	X	X	X					
	RAIN	X	X	✓	X	X					
	WINDY	X	X	X	✓	X					
	CLOUDY	X	X	X	X	✓					

Girl	AMARA	HOME	SNOW
Boy	BRUNO	GRANDPARENTS	RAIN
Boy	YOUSSEF	SCHOOL	WINDY
Girl	GIA	HOLIDAY	SUNSHINE
Girl	LUCY	DAY TRIP	CLOUDY

Page 106 - Shape Split

This page in the book is an example of a Shape Split puzzle and how to complete it.

Page 107 - Shape Split

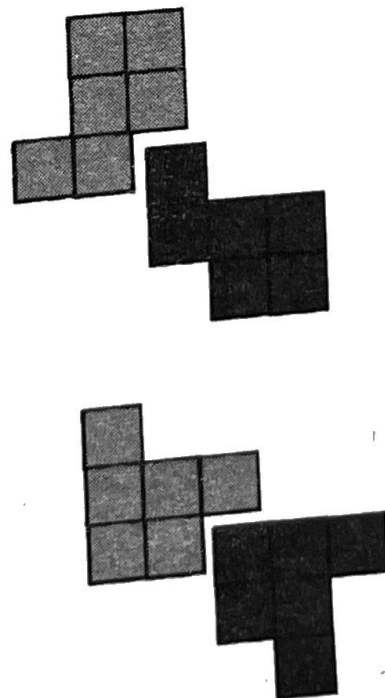

Page 108 - Shape Split

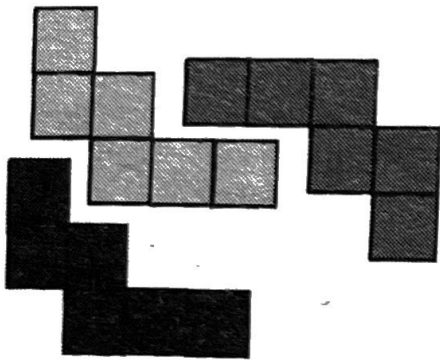
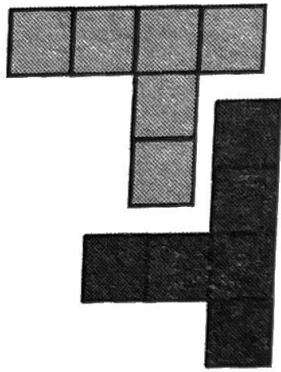

Page 109 - Shape Split

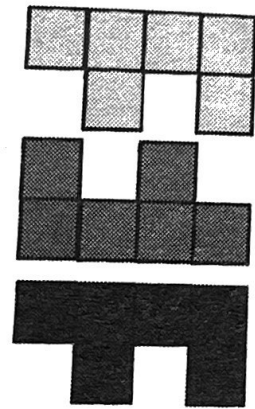
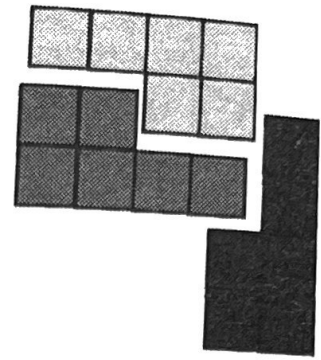

Page 110 - Break the Code

DIPLODOCUS
TRICERATOPS
VELOCIRAPTOR

Page 111 - Morse Code



Page 112 - No Four in a Row

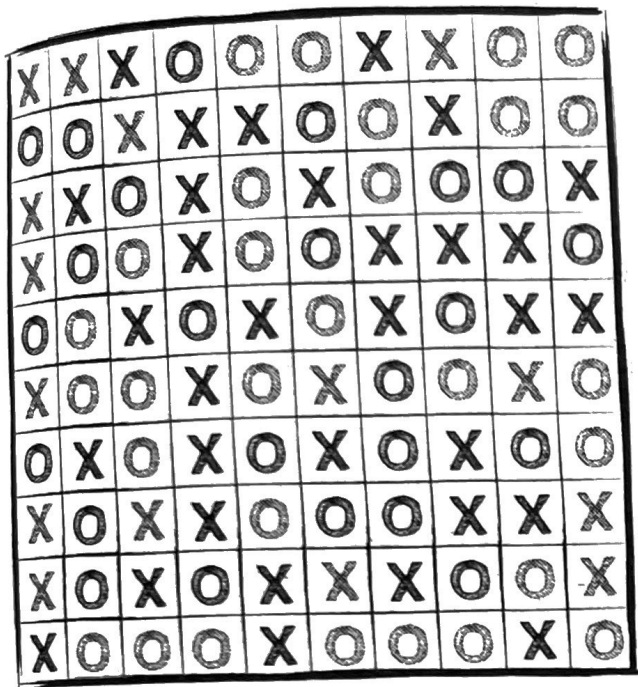

Page 113 - Kriss Kross

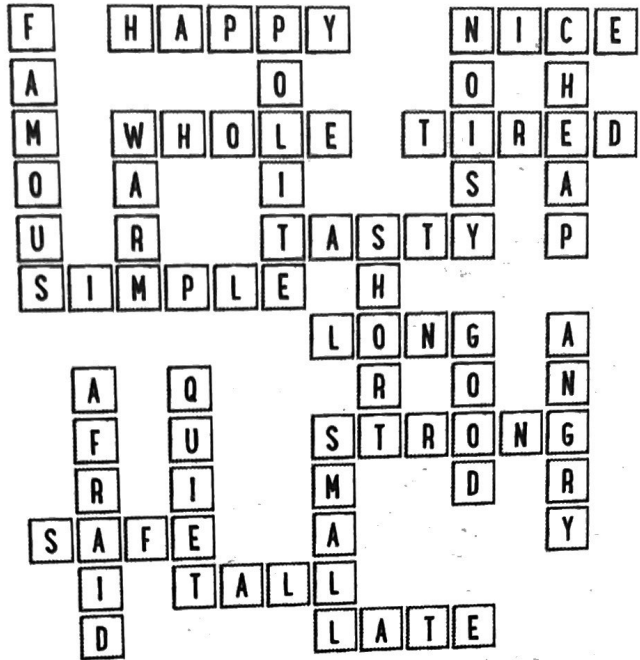

Page 114 - Key Match

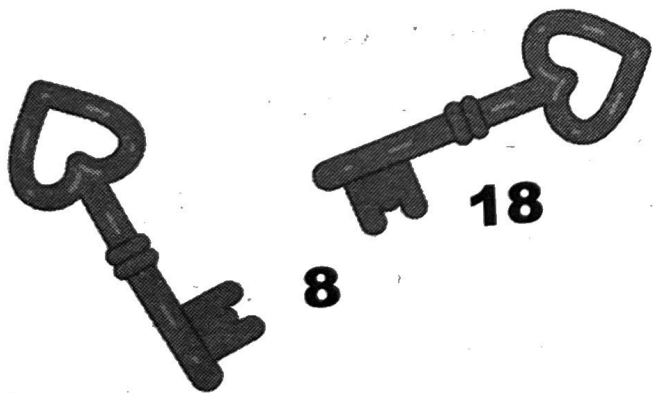

Page 115 - Sudoku 6x6

4	1	3	6	2	5
6	5	2	3	1	4
2	6	5	4	3	1
3	4	1	5	6	2
5	2	6	1	4	3
1	3	4	2	5	6

Page 116 - Battleships

This page in the book is an example of a Battleships puzzle and how to complete it.

Page 117 - Battleships

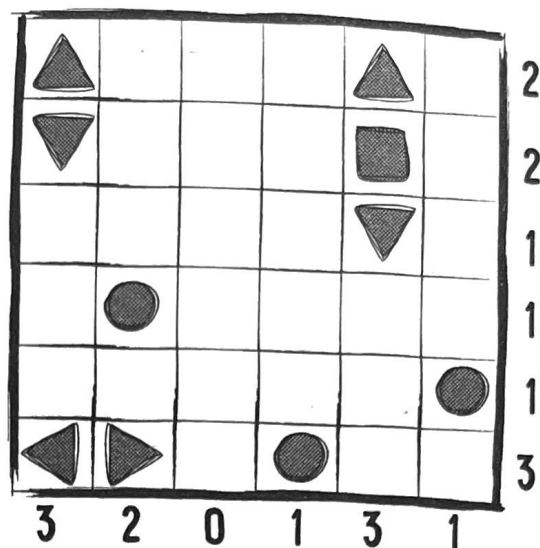

Page 118 - Battleships

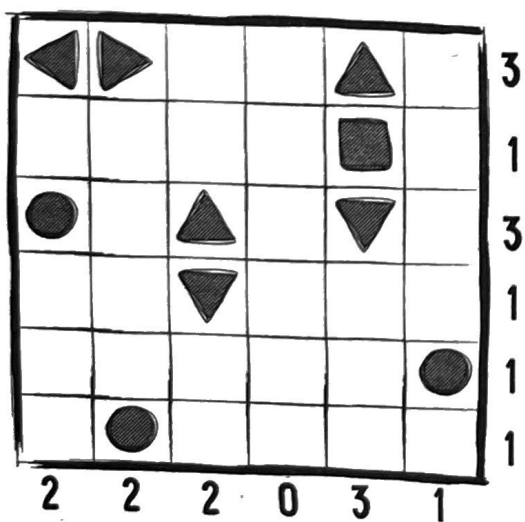

Page 119 - Battleships

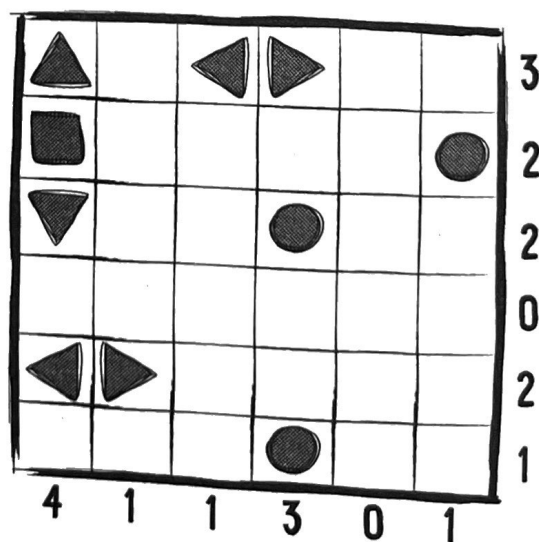

Page 120 - Battleships

Page 121 - Battleships

